

**Materiales y herramientas recomendadas**

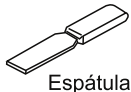

Llave ajustable



Espátula



Taladro

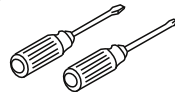

Destornillador + -



Cinta Métrica



Lápiz

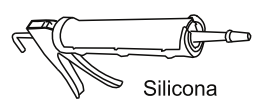

Silicona



Sierra para metales

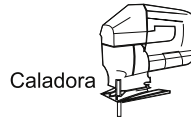

Caladora



Llave de tuercas ajustable

1.

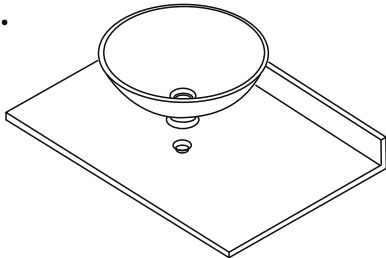

Coloque el lavamanos vessel sobre la superficie donde desea instalarlo. Si el lavamanos incluye plantilla de instalación, realice la perforación de acuerdo a las instrucciones. Si NO la incluye, realice una perforación de 1-3/4" (4.5cm) para la tubería de desagüe.

2.

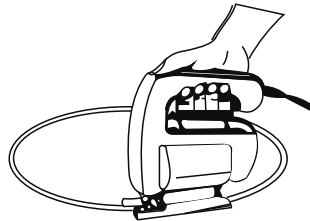

Si su modelo de lavamanos incluye la plantilla impresa en el empaque ubíquela sobre la superficie de instalación y recorte el mueble usando una caladora manual. (si el material lo permite).

3.

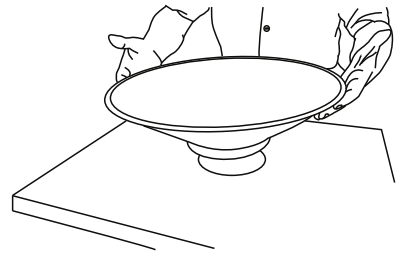

Ubique el lavamanos vessel en posición de instalación, asegúrese que el acople entre el lavamanos y la superficie quede correcto.

4.

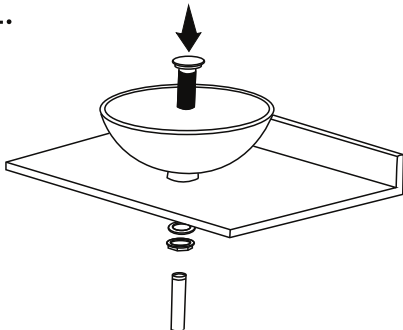

Asegure el lavamanos vessel contra la superficie instalando la tubería de desagüe. Apriete todas las piezas y asegúrese de ponerlas en la posición correcta. NO APRIETE EN EXCESO.

5.

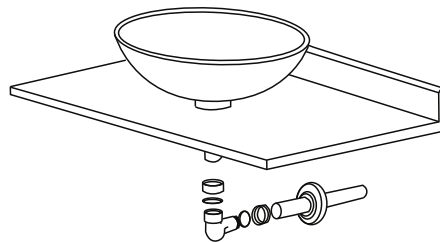

Termine de armar y conectar los abastos y el desagüe a la pared según las instrucciones del fabricante.

6.

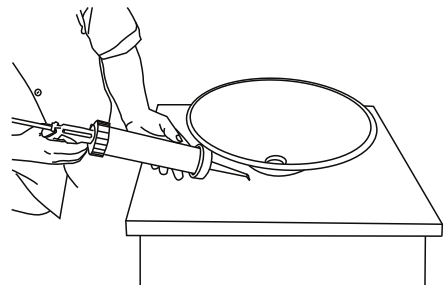

Para instalación de lavamanos cerámicos, ponga un cordón de silicona donde apoye el lavamanos. Los lavamanos de vidrio no requieren este cordón de silicona.

**INSTRUCCIONES DE CUIDADO Y MANTENIMIENTO**

Su nuevo lavamanos vessel le proporcionará años de servicio. Se debe limpiar sobre una superficie regular. La utilización de limpiadores abrasivos podría dañar el esmalte, y en general la superficie del lavamanos, no es recomendable. Limpie las superficies externas con una solución de agua jabonosa y limpie el área del lavamanos con un limpiador no abrasivo. Usar limpiadores que contengan cloro, pueden causar daños al lavamanos y greiferías y no es recomendable.

**Líneas de Atención al Cliente / Customer Services**

Bogotá: 404 88 84  
Colombia: 01 8000 51 20 30  
  
México  
Directo: (81) 8125 2000  
LADA sin costo: 01 800 705 1020

Centro América  
Guatemala: (502) 1-800-6240-109  
Costa Rica: (506) 4001-4966  
Nicaragua: (505) 1-800-2202-304  
Honduras - Tegucigalpa: (504) 2221-1203  
Honduras - San Pedro Sula: (504) 2558-0529  
Panamá: (507) 8000-202  
El Salvador: (503) 2136-8523

**Importado en México**  
**Porcelana Corona de México S.A De C.V**  
**Félix U. Gómez N°.4047 Nte.**  
**Fraccionamiento Coyoacán**  
**Monterrey, N.L., México C.P. 64510**

**Recommended Tools and Materials**



Adjustable Wrench

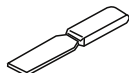

Putty Knife



Drill



Screwdrivers - +



Tape Measure

Washable marker

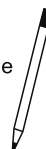

Caulk gun and caulk

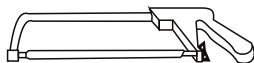

Hacksaw

Sauber Saw

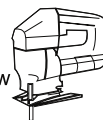

Pipe Wrench

1.

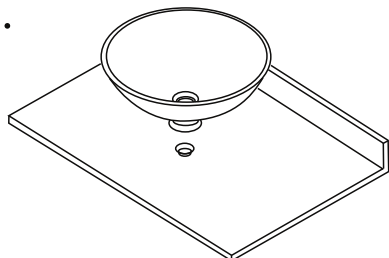

Set the lavatory over the installation surface. If lavatory includes the template, cut the hole according to the instructions. If the template isn't included cut a hole (1-3/4", 45mm) for the waste pipe.

2.

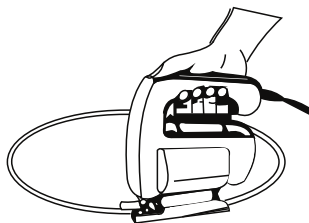

If your lavatory model includes the template printed in the box, set it over the installation surface and cut the surface using a sauber saw (if the material allow)

3.

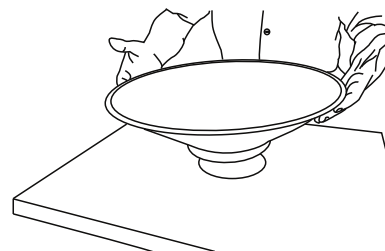

Set the vessel lavatory on installation position, ensure the properly alignment between lavatory and installation surface.

4.

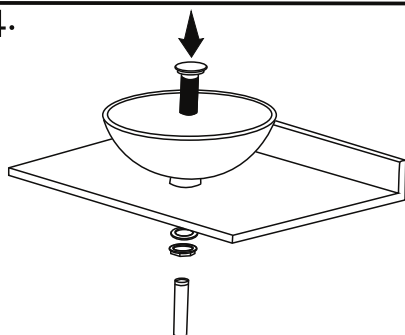

Ensure vessel lavatory against the surface installing the wastepipe. Tighten all pieces and ensure to put them on the correct position.  
**DO NOT OVERTIGHTEN**

5.

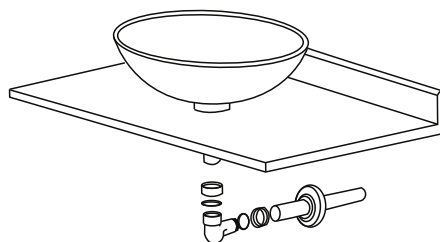

Finish to fit and connect the supply and the wastepipe according to manufacturer's recommendations.

6.

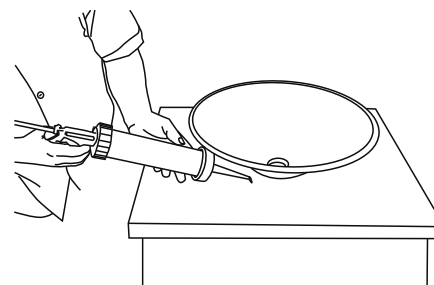

For ceramic lavatories, put a caulk bead where the lavatory it's support. Glass Lavatories doesn't need this caulk bead.

**CARE AND MAINTENANCE INSTRUCTIONS**

Your new lavatory provides you with years of service. Cleaning should be done on a regular basis. Use of scouring cleansers may remove the glaze on the basin and are not recommended. Wipe all outside surfaces with a soapy water solution and clean basin area with a non-abrasive type cleaner. Use of cleaners containing chlorine will cause damage and are not recommended.

**Líneas de Atención al Cliente / Customer Services**

Bogotá: 404 88 84  
 Colombia: 01 8000 51 20 30

México  
 Directo: (81) 8125 2000  
 LADA sin costo: 01 800 705 1020

Centro América  
 Guatemala: (502) 1-800-6240-109  
 Costa Rica: (506) 4001-4966  
 Nicaragua: (505) 1-800-2202-304  
 Honduras - Tegucigalpa: (504) 2221-1203  
 Honduras - San Pedro Sula: (504) 2558-0529  
 Panamá: (507) 8000-202  
 El Salvador: (503) 2136-8523

**Importado en México**  
**Porcelana Corona de México S.A De C.V**  
**Félix U. Gómez N°.4047 Nte.**  
**Fraccionamiento Coyoacán**  
**Monterrey, N.L., México C.P. 64510**